

ASSEMBLY GUIDE

SKU:U6259

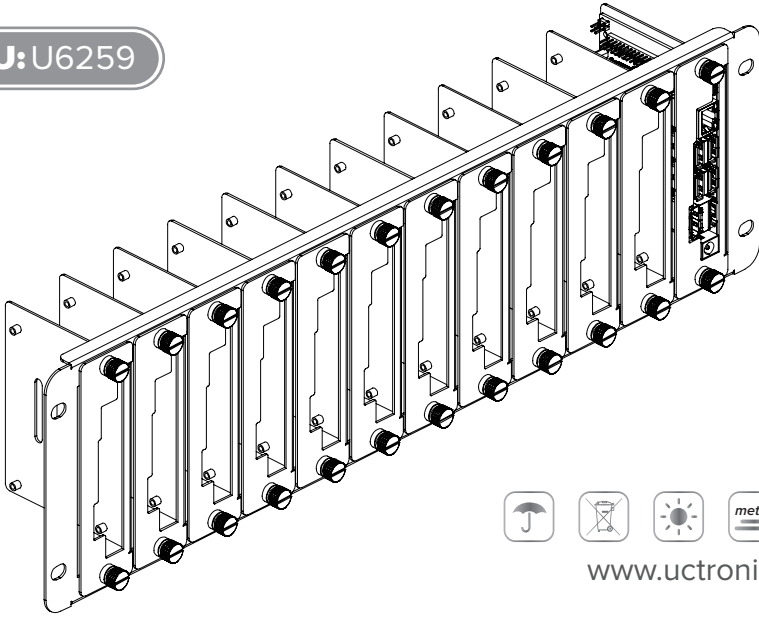

www.uctronics.com

Package Contents

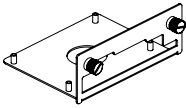

Mounting Bracket with captive
loose-off screws ×12



M2.5*5 round head
screws ×48



M6*16 rack screw ×4

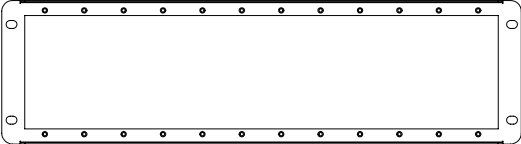

Frame ×1

Installation

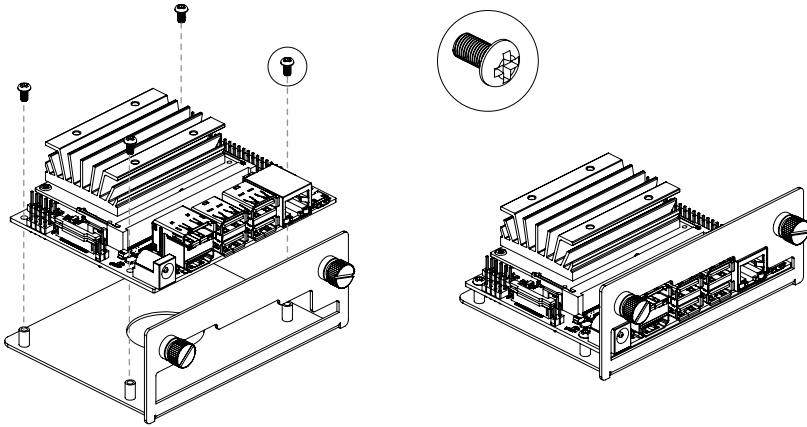

1. Attach the Jetson Nano Board to the mounting bracket with M2.5*5 screws.

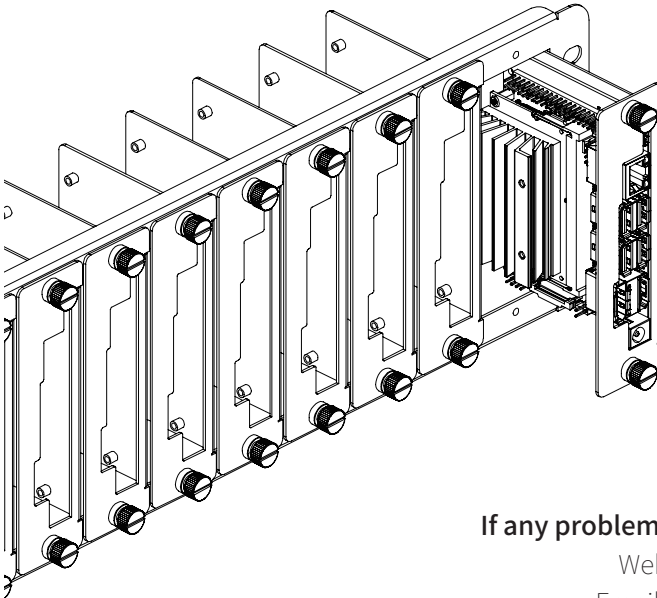

2. Insert the installed module directly, and then secure the additional captive loose-off screws in the holes on its mounting frame.

CONTACT US

If any problem, feel free to contact us.

Website: www.uctronics.com

Email: support@uctronics.com