

UCTRONICS

Assembly Instruction

SKU: U603001

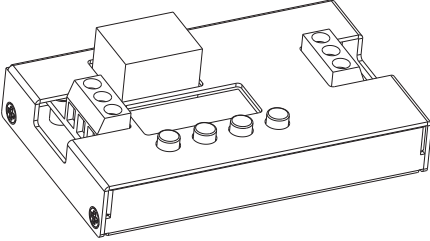

www.uctronics.com

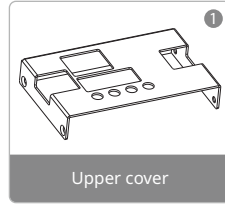

Upper cover

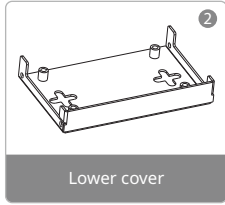

Lower cover



Truss head screw

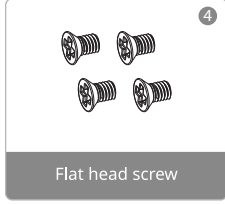

Flat head screw

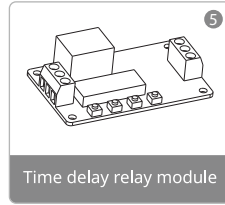

Time delay relay module

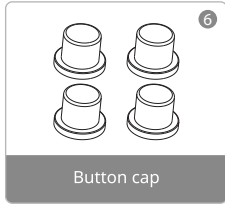

Button cap

STEP

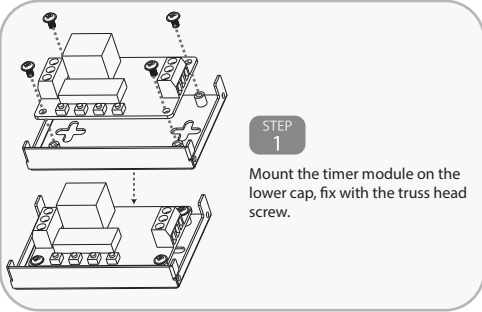

STEP

